



**VG 231 214CA**

Stainless steel control panel  
Natural gas  
Width 12" (28 cm)

**Installation accessories**

**VV 200 014**  
Connecting strip for combination with other Vario cooktops

**Optional accessories**

**VD 201 014**  
Brushed stainless steel appliance cover  
**WP 400 001**  
Wok pan made of multiple-layer material with round bottom and handle  $\varnothing$  14 <sup>3</sup>/<sub>16</sub>" height 3 <sup>15</sup>/<sub>16</sub>".

**Vario 200 series gas wok cooktop**  
**VG 231**

- Special appliance for restaurant-grade capabilities in the home kitchen
- Integrated control panel for comfortable and secure operation
- Wok burner with 17,000 BTU output. For the typical Asian quick braising and for large pots and pans
- Electric ignition of burner. Simply press the knob, turn it and hold it there until a stable flame burns

**Cooking zones**

1 three-ring wok burner.  
(250–5,000 W) 850–17,000 BTU, suitable for woks and pans up to  $\varnothing$  12 <sup>5</sup>/<sub>8</sub>".

**Features**

Brushed stainless steel cooktop.  
Three flame rings.  
Electric ignition.  
Cast-iron pan support.  
Three-ring burner of solid heat-resistant burner brass.  
Equipped for natural gas. For conversion to LP gas, LP kit (part# 622912) must be ordered.

**Safety**

All-gas valve with fine control thermoelectric safety pilot.

**Planning notes**

Maximum drawer depth 16 <sup>9</sup>/<sub>16</sub>".  
Appliance clicks into place when inserted in the countertop from above. A minimum clearance of 5 <sup>3</sup>/<sub>16</sub>" from adjacent heat-sensitive furniture or contact surfaces must be observed or thermal insulation must be installed. Due to its diameter, do not combine VL 041/040 immediately adjacent to air deflector LS041000.

Please read additional planning notes on page 104.

**Rating**

Total rating: 17,000 BTU.  
Total Amps: 1 A.  
120 V / 60 Hz  
Connecting cable 55" with plug.

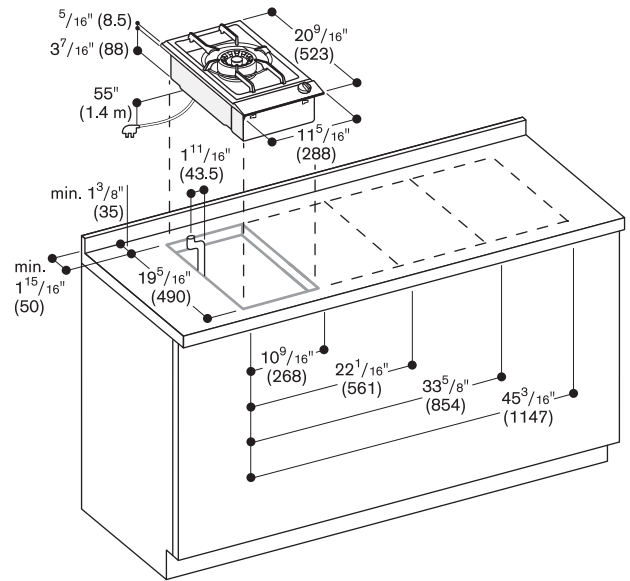

**Gas connection**

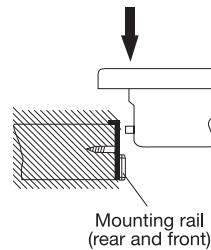
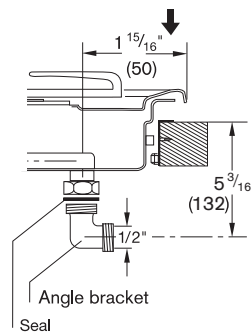

Numbers indicated inside parenthesis ( ) = mm